

WM120T

Vibration and temperature digital sensor

The WM120T vibration and temperature sensor measures temperature and vibration, providing displacement, speed and acceleration values and their spectral analysis for equipment online protection and condition monitoring.

Typical applications

Pumps	Crushers
Coolers	Mixers
Fans	General equipment
Wind turbines	
Compressors	
Gearboxes	

Technical data

Vibration

Measuring range	±20 g
Precision	0.001 g
Frequency range	0.5 Hz-20 kHz

Temperature

Measuring range	0-125°C
-----------------	---------

Power supply	POE
Communication	Ethernet MODBUS TCP
Connector	RJ45
Material	AISI 304
Operation temperature	-40° a 85°C
Sealing	IP 65
Weight	240 g

Dimensions

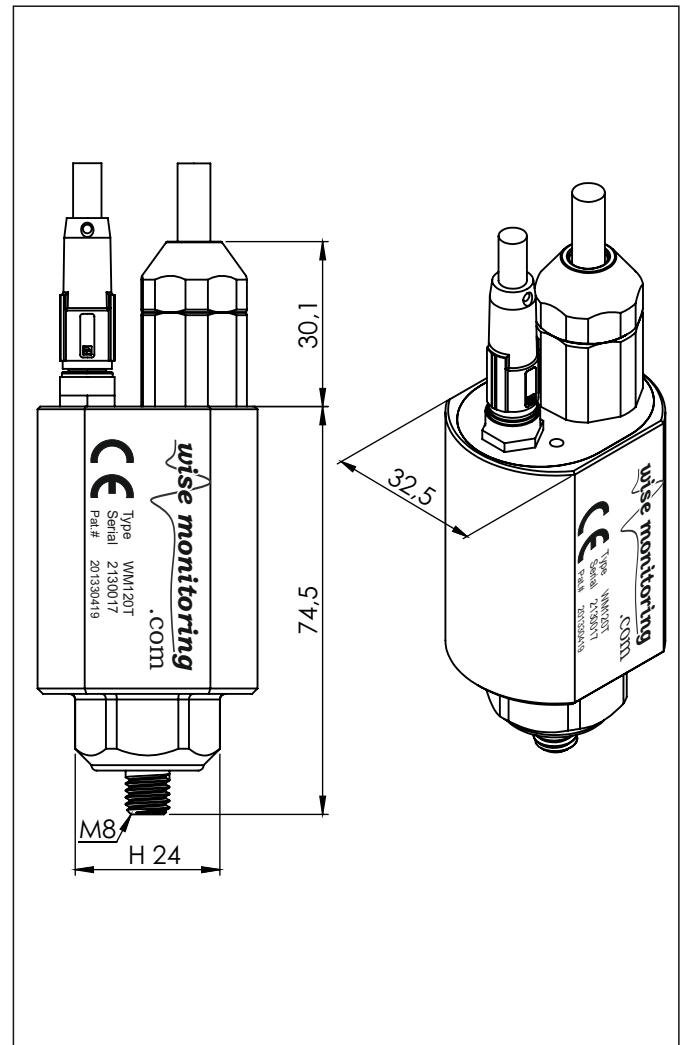

WM120T vibration and temperature sensor is a patented device under patent number 201330419

The sensor includes ADC module, DSP microprocessor and memory to analyze the signal at the measuring point and manage an interface web server for user access to information and configurable alarms.

Connector pinout Digital Input / Output

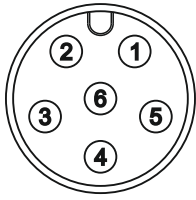

In1	BROWN
In2	WHITE
+Vext	BLUE
Out1	BLACK
Out2	GREY
0v	PINK

Internal isolated input circuit

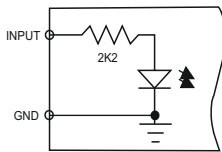

Internal isolated output circuit

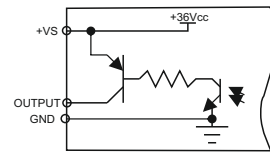

External powered two-wire inductive sensor

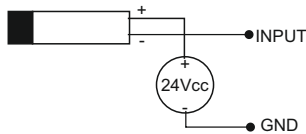

Internal powered two-wire inductive sensor

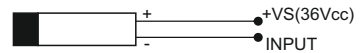

External powered three-wire pnp sensor

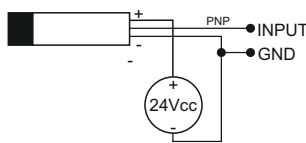

Internal powered three-wire pnp sensor

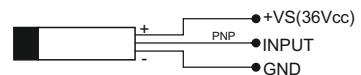

Internal powered 36VDC external relay coil

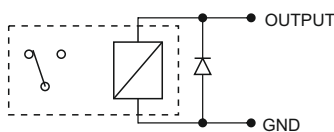

External powered 24VDC external relay coil

